

PRISM

Prism Standing Support & Posterior Slings



User Manual

PRISM MEDICAL UK

Standing Support & Posterior Sling

Application

The Standing Support and Posterior Sling is designed to be used from a sitting position in conjunction with the Freeway Stand Aid.

Standing Support Sling

The sling supports the person in facilitating the sit to stand manoeuvre and should only be used on a person that has control over their trunk muscles and that has the ability to weight bear.

Posterior Sling

The posterior sling is used in conjunction with the chest sling. It helps support the hips in the sit to stand manoeuvre.

Sling Inspection

All Prism slings are manufactured to meet and exceed the requirements of BS EN 10535:2006 'Hoists for the transfer of disabled persons– Requirements and test methods'. Slings should be inspected prior to use and after washing. Damaged or badly worn slings should be discarded... The label on the sling contains vital information to identify the sling—if any part of the label becomes illegible, then it must be removed from service and replaced.

The sling should be visually inspected with regard to the following items:-

- Any signs of damage (i.e. Cuts, frays, tears, burns) to the sling straps
- Any signs of stitching becoming undone on any part of the sling
- Any signs of the fabric being stretched, tearing or undue wear
- Any signs of discolouring or bleaching on the material
- Is the sling complete? i.e. all straps present, stiffeners in place - where applicable, etc
- Label clearly legible

Compatibility

The issue of sling compatibility with various manufacturers' hoists has been a concern for specifiers for a number of years, an issue that is compounded by the increased number of companies supplying hoists and slings.

Some hoist/sling manufacturers will state that only slings manufactured by them can be used on their hoists and vice versa. This is their policy only and is **NOT** a legal requirement. A risk assessment must still be completed even if the same manufacturer of hoist and sling are to be used, and the specifier simply has to state that the carry bar is of a similar design and that the sling manufacturer has authorised its use on it.

A comprehensive list is available separately and your local agent will be able to provide assistance with compatibility issues.

Maximum Load (Safe Working Load - SWL)

The maximum load for the sling is clearly marked on the label of the sling. The maximum load will also be displayed on the hoist and any detachable elements of the hoisting system.

Sling Dimensions

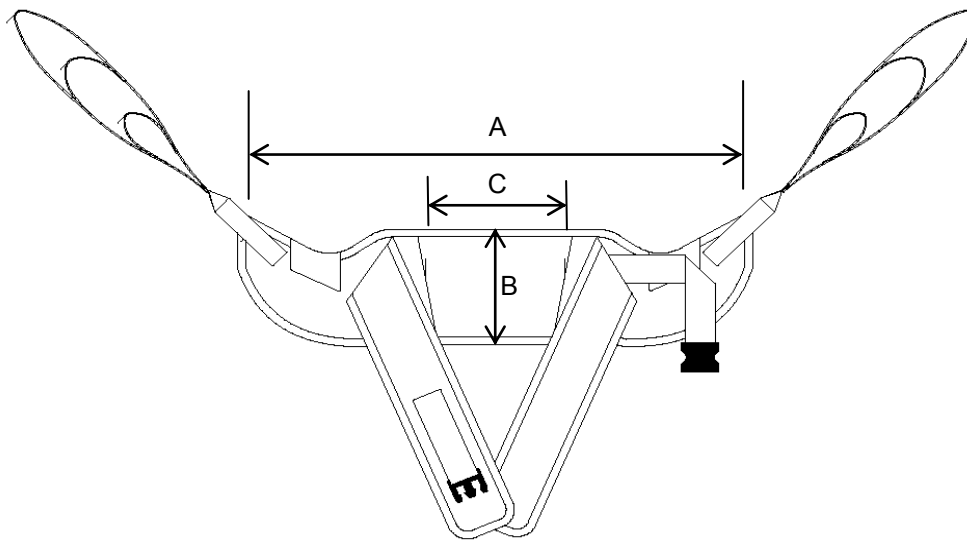

	A	B	C
Small	820	220	260
Medium	860	220	300
Large	970	220	300
X Large	1170	270	340

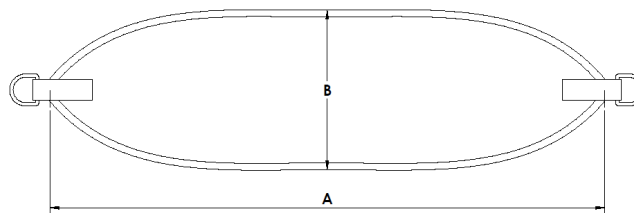

	A	B
Small	830	210
Medium	890	230
Large	1030	300
X Large	1140	400

All dimensions have a tolerance of +/- 20mm

How to fit the Standing Support Strap

Note: The person to be transferred shall be referred to as “the person”.

Ensure the label and grab handles are facing away from the person before commencing the fitting procedure below.

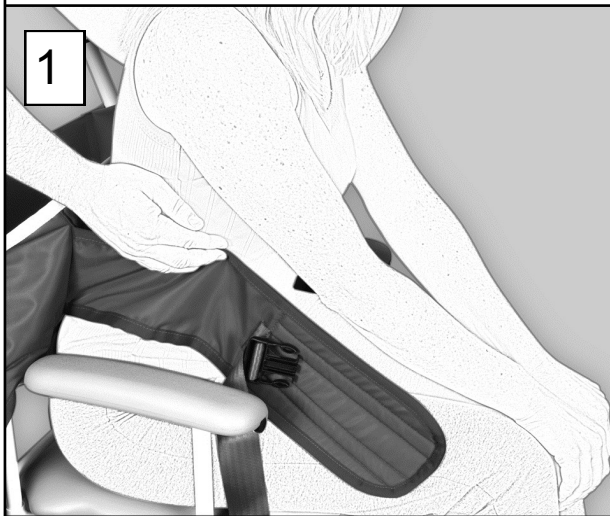

1

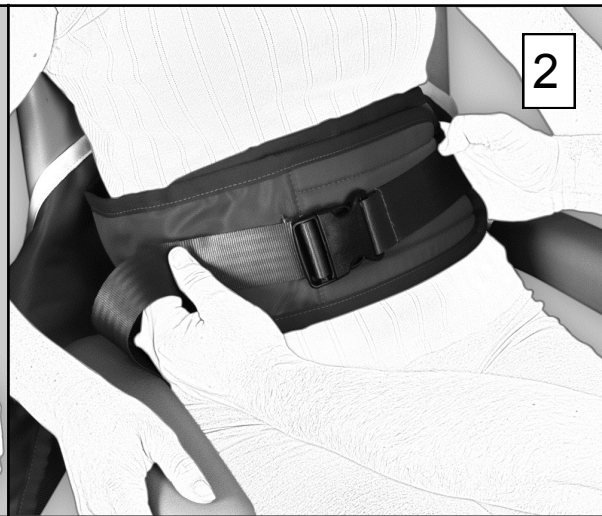

2

Place the sling down the back to a position just beneath the shoulder blades and above the belt line. If the sling can not be introduced from behind, apply the sling in a position level with the person.

Bring the two sections of the chest strap around the person's chest and fasten securely using the hook & loop and buckle fastening. Note: the chest strap is purely intended for the security of the person and is not weight bearing.



3

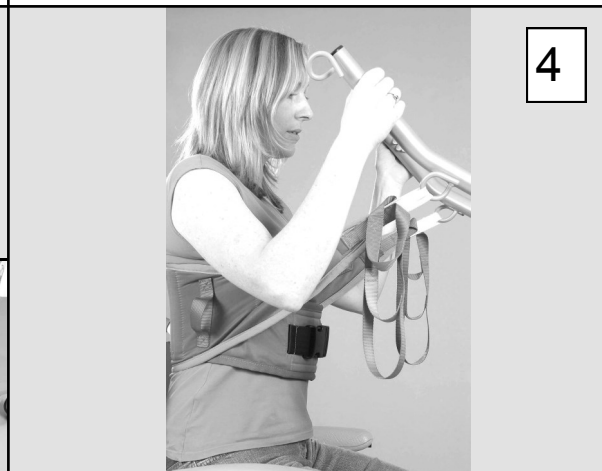

4

Place the person's feet on to the foot plate and adjust the knee pad (the knee pad should be positioned at the top of the shin avoiding the knee joint) the two straps should now be attached to the carry bar hooks. Raise the carry bar just enough to tension the straps and **ensure that they are still securely attached**. As the person is about to be lifted check the chest strap for tension and comfort. Re-adjust when required.

Alternatively you can attach the sling to the lower sling hooks, this will facilitate an alternative standing procedure.

Important - always re-assess for client's co-operation and capability when using this sling.

To remove the sling, carry out the fitting procedure in reverse.

Important - always peel the sling away from the person to avoid skin friction and movement.

Notes

The above & following techniques are for guidance only and you must comply with your local policies
If in doubt, consult your moving and handling advisor

Using the Posterior Sling in conjunction with the Standing Support Sling

The posterior straps must first be attached to the Freeway SA-160 by following the diagrams below:

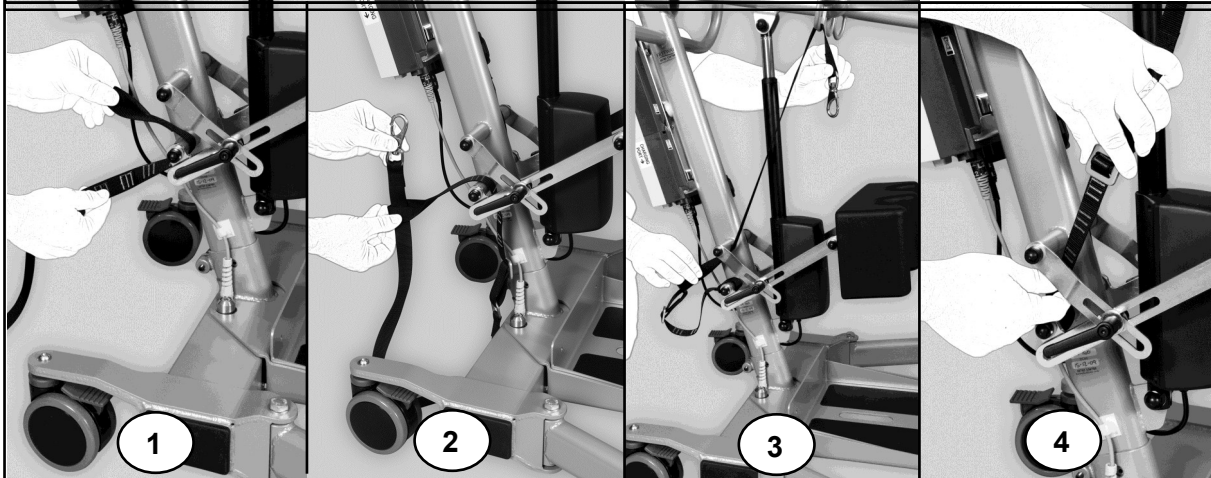

1. Thread loop of posterior strap under lower bar.
2. Thread hook through the end of the loop and pull through to form attachment to lower bar.
3. Thread hook end of the strap to the inside of the top bar and thread through the metal loop on the boom of the Freeway SA160.
4. Adjust the length of the strap using the slider buckle to suit the individual.

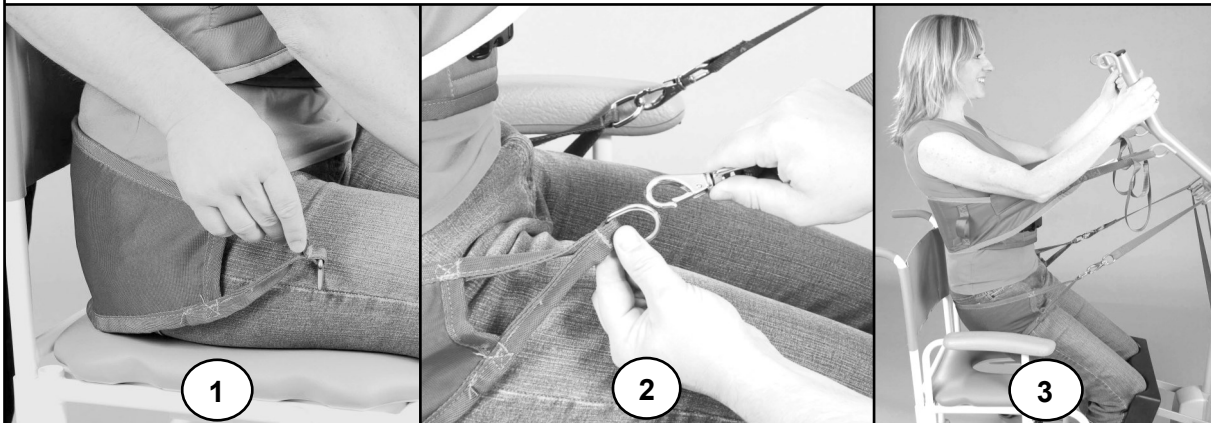

1. Fit the Standing support strap as described on the previous page (Items 1 & 2) and then introduce the posterior sling level with the persons hips.
2. Attach the posterior sling to the posterior straps.
3. Introduce the Freeway SA-160 as described in the previous section (item 3). Raise the carry bar just enough to tension the straps and **ensure that they are still securely attached and there is no twists in the posterior straps.**

As you start the lifting procedure the posterior sling will support the majority of the lift, **(If NOT adjust the chest sling straps or the posterior straps placed at the bottom near the hoist attachment bar as shown in item 4 above)** as the standing continues the chest sling will gradually take over, once in standing the posterior sling will be relaxed to allow access to clothing.

Only use the Standing Support sling & Posterior sling with clients with the ability to stand.

Do not fix the posterior straps to anything other than the "D" rings on the posterior sling (failure to do so may cause material fracture and may also compromise safety!)

To remove the sling, carry out the fitting procedure in reverse.

Important - always peel the sling away from the person to avoid skin friction and movement.

When the Posterior Straps are not in use

If you wish to keep the straps attached to the Stand Aid whilst not in use, the hook on the strap must NOT be clipped onto the D Ring see image A. This will cause damage to the hook. ONLY clip the hook onto the strap material itself - see image B



DECLARATION OF CONFORMITY

Manufacturers Name: Prism Medical UK Ltd

MHRA Registration No: CA 013248

Manufacturers Address: Unit 4 Jubilee Business Park, Jubilee Way,
Grange Moor, Wakefield,
WF4 4TD, UK
Tel +44 (0) 844 980 2260

Declares that the manufactured product:-

Product Name: Prism Standing Support & Posterior Slings
Product Options : Small, Medium, Large, XL Large.

Conforms to the following European Union Council Directives:-

Directive 93/42/EEC and all amendments up to Directive 2007/47/EC

Classification Class 1, Low Risk Medical Device
Tested in accordance with BS EN ISO 10535:2006 & IEC 60601 3rd Edition

Supplementary Information:

The undersigned declares the product herewith complies with the requirements set out above and carries the CE mark accordingly.

The Technical Construction File required by this directive is maintained by the manufacturer as detailed above.

Signed: _____

Date: 14th November 2014

Craig Wright, Manufacturing Director

SLING CARE: LAUNDERING

GENERAL.

Sensitive laundering of lifting slings will extend the service life of the product. Conversely, improper laundering will reduce the service life and possibly affect the strength and integrity of the sling.

To be avoided:

- Use of bleach at washing, particularly hypochlorite [may cause structural damage]
- Overheating the sling [temperatures in excess of 100° may cause extreme shrinkage and structural damage]

Use of non-biological detergents is not recommended (especially Fairy Non - Bio): as these types of detergent contain bleaching agents that can degrade the strength of the sling.

The use of fabric conditioners is not recommended.

Any hook & loop fastenings should be closed prior to laundering to avoid the 'hook' side damaging the sling or other items laundered with it.

GENERAL SOILING.

The sling should be laundered with soap or detergent at 50°C on a standard domestic cycle.

DISINFECTION.

The sling should be laundered to ensure a 'period at temperature' of:

- 10 minutes at 65°C
- 3 minutes at 72°C

Following NHS guidelines, extra time should be added to ensure thorough mixing of hot water through the wash load.

It may be that available equipment does not allow the required level of temperature control. The sling may be washed on a 90°C wash cycle, though it is likely that some moderate shrinkage and/or colour bleed will occur.

DRYING.

Slings will air dry quite quickly in a warm room.

Slings should not be placed over radiators or convectors.

Slings may be **CAREFULLY** tumble dried on a cool [60°C] setting and short cycle.

The sling should be checked at intervals not exceeding 5 minutes.

Do not allow the sling to overheat.

The sling should last in excess of 5 years if the above guidelines are adhered to. All Prism Slings have a manufacturers guarantee of 12 months.

Care Plan Information

All slings in the Prism range have space on the labels to record the clients name. Each sling has unique individually colour coded positioning loops which helps maintain good lifting practice. The loop options facilitate variable positions to suit the individual during the standing procedure.

The posterior strap is adjustable and has coloured inserts to identify the correct position when adjusting for different clients.

Date of Assessment :		FIM Score:	
Clients Name:			
Approx Weight:		D.O.B:	
Type of Sling:		Size:	
	Sling Straps Coloured loop Options		
Standing Support Loop:	White <input type="checkbox"/> Orange <input type="checkbox"/> Purple <input type="checkbox"/> Blue <input type="checkbox"/> Other <input type="checkbox"/>		
Posterior strap, Slider buckle position:	Green <input type="checkbox"/> Yellow <input type="checkbox"/> Orange <input type="checkbox"/> Red <input type="checkbox"/>		
Comments			

If you have any questions regarding the use of this equipment, please contact Prism Medical UK, or your local authorised dealer.



PRISM MEDICAL UK



Prism Medical UK, Unit 4 Jubilee Business Park,
Jubilee Way, Grange Moor, Wakefield, WF4 4TD.

Tel +44 (0) 844 980 2260

www.prismmedical.co.uk

info@prismmedical.co.uk

This document conforms to BS EN ISO 10535:2006 Requirements

